

PROPRIETARY AND CONFIDENTIAL

THE INFORMATION CONTAINED IN THIS DRAWING IS THE SOLE PROPERTY OF PRECISION SERVICE & PUMPS INC.. ANY REPRODUCTION IN PART OR AS A WHOLE WITHOUT THE WRITTEN PERMISSION OF PRECISION SERVICE & PUMPS INC. IS PROHIBITED.

MATERIAL

UNLESS OTHERWISE SPECIFIED:
 DIMENSIONS ARE IN MILLIMETERS
 TOLERANCES:
 ANGULAR: MACH ± .5 BEND ± 1.0
 ± 1MM
 ONE PLACE DECIMAL ± 0.1MM
 THREE PLACE DECIMAL ± 0.05MM

NAME	DATE
DRAWN PT	1/19/2012
CHECKED	
CHECKED	

PSP WO #: 8055		TITLE: SHIPPING CONTAINER		SIZE B	REV
				SHEET 1 OF 5	

PRECISION
 SERVICE & PUMPS INC.
EST. 1992

Ph. 604.850.7010 Fx. 604.850.9666
 www.precision-pumps.com
 1334 Riverside, Abbotsford B.C. V2S 8J2

C.S. JACKSON HEAVY EQUIPMENT SERVICES LTD.
SUNSHINE COAST REGIONAL DISTRICT

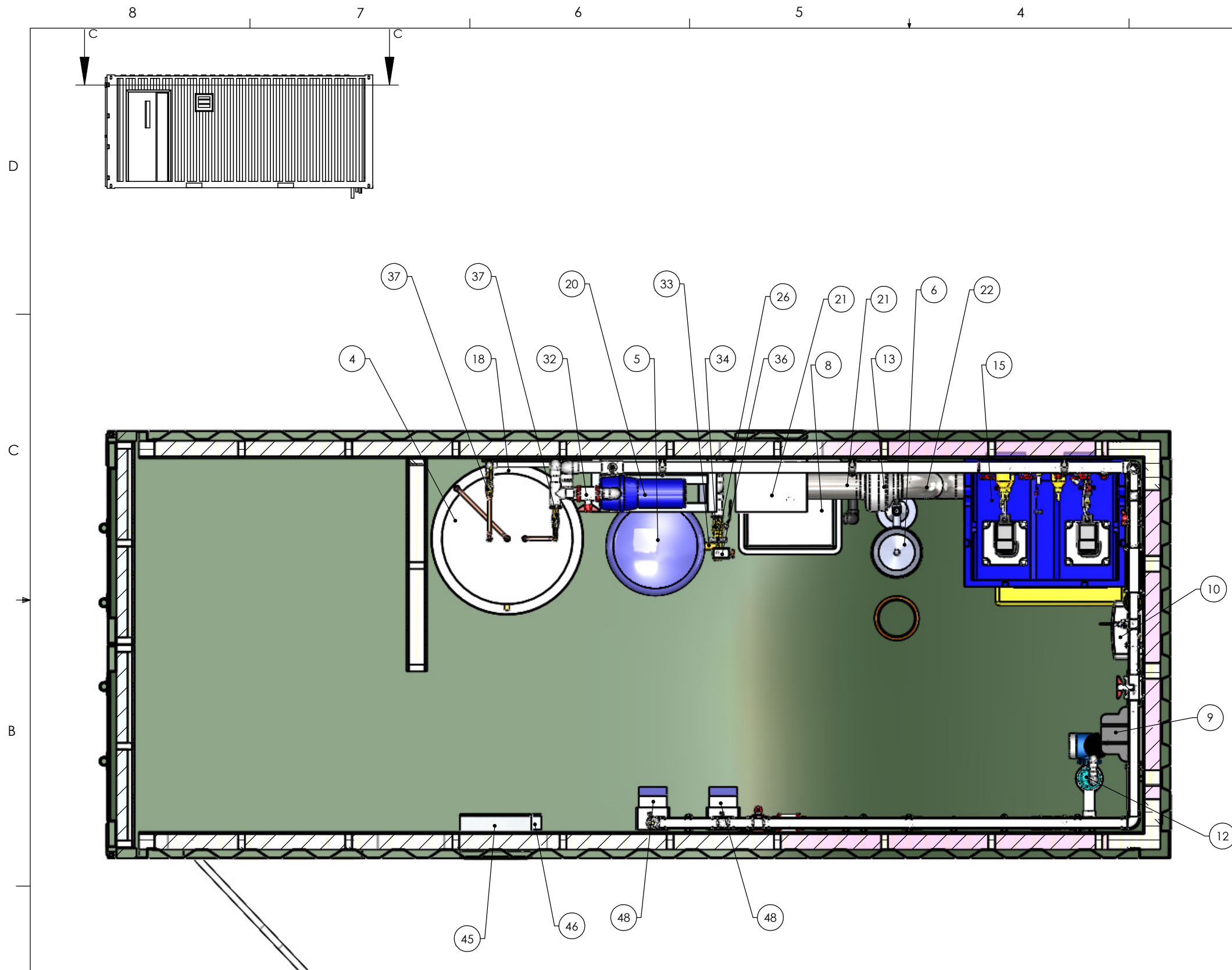

ITEM NO.	PART NUMBER	DESCRIPTION	QTY.
1	SHIPPING CONTAINER 20FT 8055	C/W INSULATION, PLYWOOD SHEETING & PAINT	1
2	SPILL CONTAINMENT SKID	ENPAC MODEL #5117-YE 83.6 L	1
3	20L PAIL		1
4	HOT WATER TANK	A.O. SMITH DEN-120	1
5	PRESSURE TANK	62 GAL. WELL-X-TROL WX-251	1
6	EMERGENCY EYE WASH & SHOWER	GUARDIAN G1950HFC-FC20	1
7	THERMOSTATIC MIXING VALVE	44 GAL. CAP. GUARDIAN G3800	1
8	LAUNDRY SINK	FL-1 75 LITER	1
9	TURBIDITY ANALYZER	HACH 1720E	1
10	CHLORINE ANALYZER	HACH CL17	1
11	PRESSURE REDUCING VALVE	WATTS 223-S 12MM C/W STRAINER	1
12	AIR RELEASE VALVE	AIR RELEASE VALVE	1
13	IN LINE VENT FAN	FANTECH FR 160 150MM 115V	1
14	FIXED LOUVERS	300MM FLANGED	2
15	CLEARTECH CHLORINATION SYSTEM	DUPLEX GRUNDFOS DDI 209 HYPOCHLORITE METERING SYSTEM	1
16	FLOW METER EH PROMAG 50W	50MM	1
18	TANK PAN	850MM	1
20	PUMP CENTRIFUGAL SELF-PRIMING	GOULDS GT-07	1
21	VENTILATION PLENUM	150MM GALVANIZED STEEL	1
22	VENTILATION TUBE	150MM GALVANIZED STEEL	1
23	STATIC MIXER	50MM	1
24	TRUE UNION BALL VALVE	50MM SCH 80 PVC	3
25	CHEMTECH INJECTION NOZZLE	6MM	1
26	GUAGE-SNUBBER ASSEMBLY	0-120 PSI LF GUAGE/6MM BV/SNUBBER	5
27	UV PURE FLEX TUBE	18MM STAINLESS STEEL	2
28	BALL VALVE 25MM	2-Piece 600 WOG Brass Ball Valve	5
29	RISER CHECK VALVE	25MM BRASS	2
30	UV PURE SOLENOID VALVE		2
31	BALL VALVE 6MM	2-Piece 600 WOG Brass Ball Valve	4
32	TRUE UNION BALL VALVE	37MM SCH 80 PVC	1
33	TANK TEE	30MM X 330 BRASS	1
34	BALL VALVE 30MM BRASS	2-Piece 600 WOG Brass Ball Valve	1
35	HOSE BIB	20MM BRASS	1
36	PRESSURE SWITCH	40-60 PSI	1
37	BALL VALVE 18MM BRASS	2-Piece 600 WOG Brass Ball Valve	3
38	TRUE UNION BALL VALVE	18MM SCH 80 PVC	2
39	SINK FAUCET ASSEMBLY		1
40	NEEDLE VALVE	McMASTER CARR #4995K13	1
41	TRUE UNION BALL VALVE	25MM SCH 80 PVC	1
45	LOUVERS	406MM X 406MM ALUMINUM	1
46	DAMPER ACTUATOR	BELIMO AF120(-S)US	1
47	PRESSURE TRANSDUCER	ENDRESS & HAUSER PMC 71 0-60 PSI PRESSURE TRANSDUCER	1
48	UV PUR UV DISINFECTION UNIT	UV PURE HALLET 30X	2

SECTION C-C
SCALE 1 : 25

PRECISION Ph. 604.850.7010 Fx. 604.850.9666
 SERVICE & PUMPS INC.: 1334 Riverside, Abbotsford B.C. V2S 8J2
EST. 1992 www.precision-pumps.com

PROPRIETARY AND CONFIDENTIAL

THE INFORMATION CONTAINED IN THIS DRAWING IS THE SOLE PROPERTY OF PRECISION SERVICE & PUMPS INC.. ANY REPRODUCTION IN PART OR AS A WHOLE WITHOUT THE WRITTEN PERMISSION OF PRECISION SERVICE & PUMPS INC. IS PROHIBITED.

UNLESS OTHERWISE SPECIFIED:
 DIMENSIONS ARE IN MILLIMETERS
 TOLERANCES:
 ANGULAR: MACH ± .5 BEND ± 1.0
 ± 1MM
 ONE PLACE DECIMAL ± 0.1MM
 THREE PLACE DECIMAL ± 0.05MM

NAME	DATE
DRAWN PT	1/19/2012
CHECKED	
CHECKED	

C.S. JACKSON HEAVY EQUIPMENT SERVICES LTD.

SUNSHINE COAST REGIONAL DISTRICT

EGMONT COVE WATER TREATMENT PLANT

TITLE: TOP

SHEET 2 OF 5

PSP WO #: 8055

SIZE **B** REV

8 7 6 5 4 3 2 1

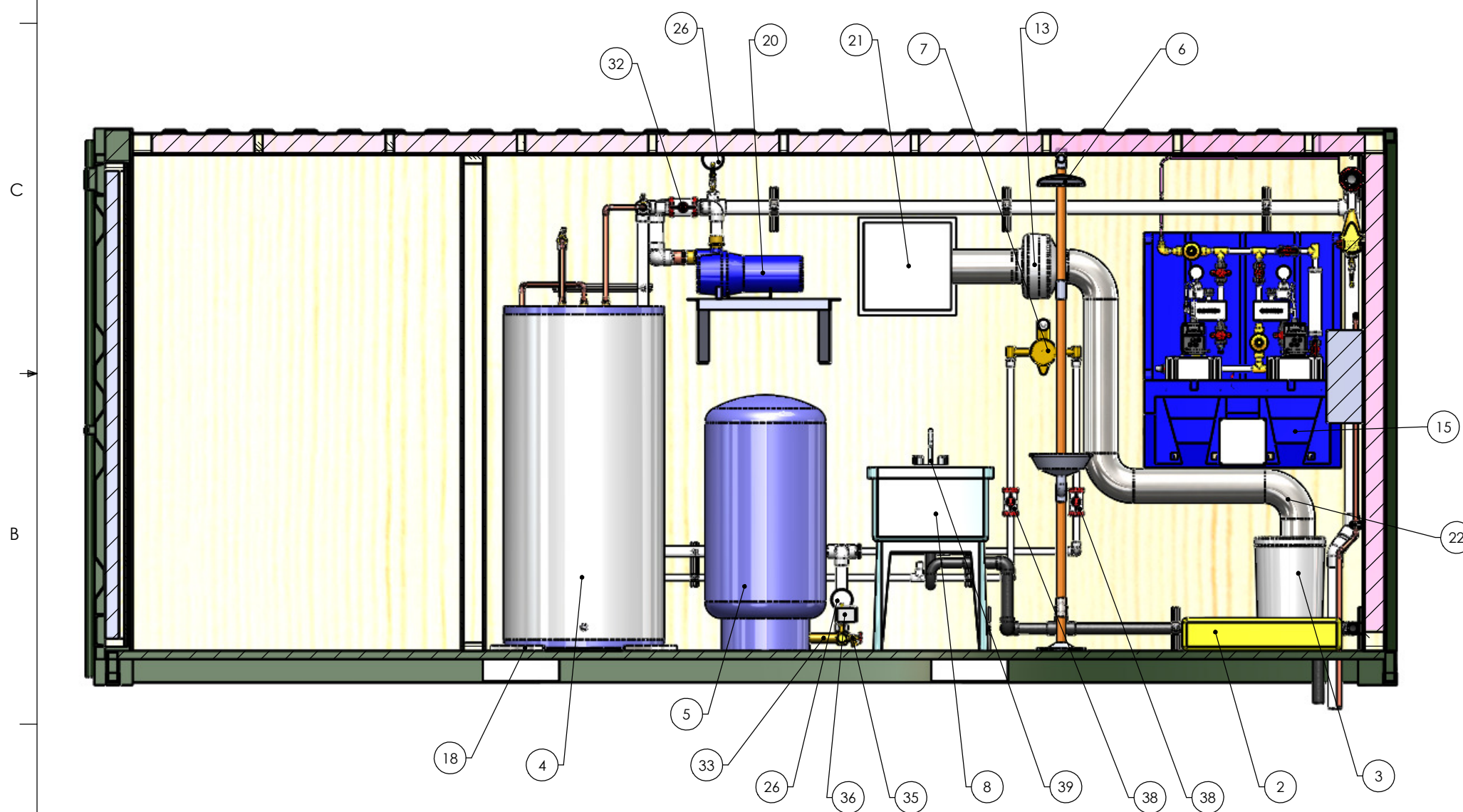
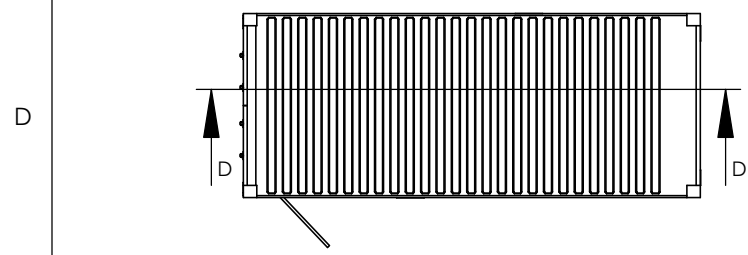

SECTION D-D
SCALE 1 : 25

ITEM NO.	PART NUMBER	DESCRIPTION	QTY.
1	SHIPPING CONTAINER 20FT 8055	C/W INSULATION, PLYWOOD SHEETING & PAINT	1
2	SPILL CONTAINMENT SKID	ENPAC MODEL #5117-YE 83.6 L	1
3	20L PAIL		1
4	HOT WATER TANK	A.O. SMITH DEN-120	1
5	PRESSURE TANK	62 GAL. WELL-X-TROL WX-251	1
6	EMERGENCY EYE WASH & SHOWER	GUARDIAN G1950HFC-FC20	1
7	THERMOSTATIC MIXING VALVE	44 GAL. CAP. GUARDIAN G3800	1
8	LAUNDRY SINK	FL-1 75 LITER	1
9	TURBIDITY ANALYZER	HACH 1720E	1
10	CHLORINE ANALYZER	HACH CL17	1
11	PRESSURE REDUCING VALVE	WATTS 223-S 12MM C/W STRAINER	1
12	AIR RELEASE VALVE	AIR RELEASE VALVE	1
13	IN LINE VENT FAN	FANTECH FR 160 150MM 115V	1
14	FIXED LOUVERS	300MM FLANGED	2
15	CLEARTECH CHLORINATION SYSTEM	DUPLEX GRUNDFOS DDI 209 HYPOCHLORITE METERING SYSTEM	1
16	FLOW METER EH PROMAG 50W	50MM	1
18	TANK PAN	850MM	1
20	PUMP CENTRIFUGAL SELF-PRIMING	GOULDS GT-07	1
21	VENTILATION PLENUM	150MM GALVANIZED STEEL	1
22	VENTILATION TUBE	150MM GALVANIZED STEEL	1
23	STATIC MIXER	50MM	1
24	TRUE UNION BALL VALVE	50MM SCH 80 PVC	3
25	CHEMTECH INJECTION NOZZLE	6MM	1
26	GUAGE-SNUBBER ASSEMBLY	0-120 PSI LF GUAGE/6MM BV/SNUBBER	5
27	UV PURE FLEX TUBE	18MM STAINLESS STEEL	2
28	BALL VALVE 25MM	2-Piece 600 WOG Brass Ball Valve	5
29	RISER CHECK VALVE	25MM BRASS	2
30	UV PURE SOLENOID VALVE		2
31	BALL VALVE 6MM	2-Piece 600 WOG Brass Ball Valve	4
32	TRUE UNION BALL VALVE	37MM SCH 80 PVC	1
33	TANK TEE	30MM X 330 BRASS	1
34	BALL VALVE 30MM BRASS	2-Piece 600 WOG Brass Ball Valve	1
35	HOSE BIB	20MM BRASS	1
36	PRESSURE SWITCH	40-60 PSI	1
37	BALL VALVE 18MM BRASS	2-Piece 600 WOG Brass Ball Valve	3
38	TRUE UNION BALL VALVE	18MM SCH 80 PVC	2
39	SINK FAUCET ASSEMBLY		1
40	NEEDLE VALVE	McMASTER CARR #4995K13	1
41	TRUE UNION BALL VALVE	25MM SCH 80 PVC	1
45	LOUVERS	406MM X 406MM ALUMINUM	1
46	DAMPER ACTUATOR	BELIMO AF120(-S)US	1
47	PRESSURE TRANSDUCER	ENDRESS & HAUSER PMC 71 0-60 PSI PRESSURE TRANSDUCER	1
48	UV PUR UV DISINFECTION UNIT	UV PURE HALLET 30X	2

A

PRECISION Ph. 604.850.7010 Fx. 604.850.9666
 SERVICE & PUMPS INC.: 1334 Riverside, Abbotsford B.C. V2S 8J2
EST. 1992 www.precision-pumps.com

PROPRIETARY AND CONFIDENTIAL

THE INFORMATION CONTAINED IN THIS DRAWING IS THE SOLE PROPERTY OF PRECISION SERVICE & PUMPS INC.. ANY REPRODUCTION IN PART OR AS A WHOLE WITHOUT THE WRITTEN PERMISSION OF PRECISION SERVICE & PUMPS INC. IS PROHIBITED.

UNLESS OTHERWISE SPECIFIED:
 DIMENSIONS ARE IN MILLIMETERS
 TOLERANCES:
 ANGULAR: MACH ± .5 BEND ± 1.0
 ± 1MM
 ONE PLACE DECIMAL ± 0.1MM
 THREE PLACE DECIMAL ± 0.05MM

	NAME	DATE
DRAWN	PT	1/19/2012
CHECKED		
CHECKED		

C.S. JACKSON HEAVY EQUIPMENT SERVICES LTD.
SUNSHINE COAST REGIONAL DISTRICT

EGMONT COVE WATER TREATMENT PLANT

TITLE: LEFT SIDE WALL

SHEET 3 OF 5

8 7 6 5 4 3 2 1

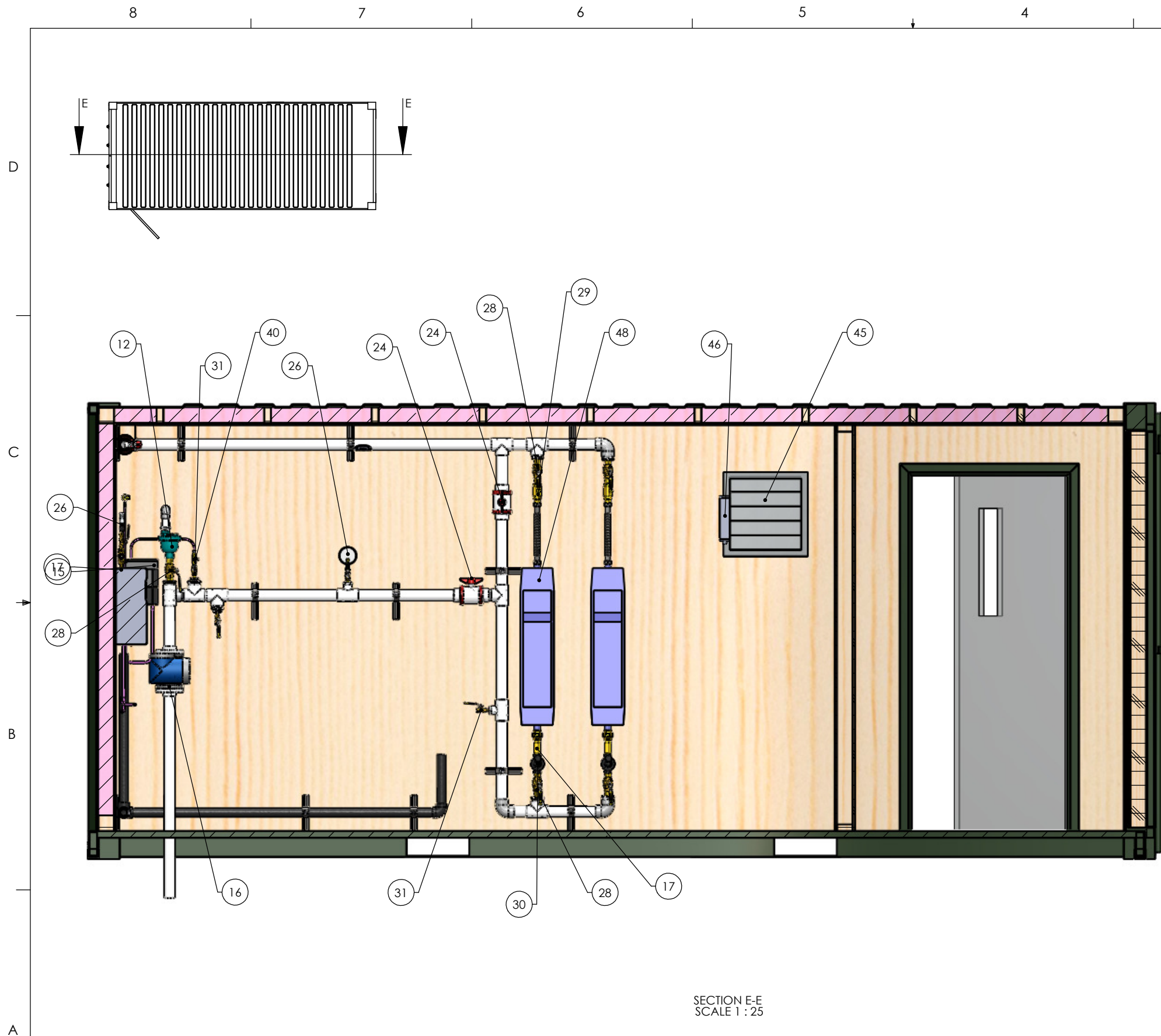

SECTION E-E
SCALE 1 : 25

ITEM NO.	PART NUMBER	DESCRIPTION	QTY.
1	SHIPPING CONTAINER 20FT 8055	C/W INSULATION, PLYWOOD SHEETING & PAINT	1
2	SPILL CONTAINMENT SKID	ENPAC MODEL #5117-YE 83.6 L	1
3	20L PAIL		1
4	HOT WATER TANK	A.O. SMITH DEN-120	1
5	PRESSURE TANK	62 GAL. WELL-X-TROL WX-251	1
6	EMERGENCY EYE WASH & SHOWER	GUARDIAN G1950HFC-FC20	1
7	THERMOSTATIC MIXING VALVE	44 GAL. CAP. GUARDIAN G3800	1
8	LAUNDRY SINK	FL-1 75 LITER	1
9	TURBIDITY ANALYZER	HACH 1720E	1
10	CHLORINE ANALYZER	HACH CL17	1
11	PRESSURE REDUCING VALVE	WATTS 223-S 12MM C/W STRAINER	1
12	AIR RELEASE VALVE	AIR RELEASE VALVE	1
13	IN LINE VENT FAN	FANTECH FR 160 150MM 115V	1
14	FIXED LOUVERS	300MM FLANGED	2
15	CLEARTECH CHLORINATION SYSTEM	DUPLEX GRUNDFOS DDI 209 HYPOCHLORITE METERING SYSTEM	1
16	FLOW METER EH PROMAG 50W	50MM	1
18	TANK PAN	850MM	1
20	PUMP CENTRIFUGAL SELF-PRIMING	GOULDS GT-07	1
21	VENTILATION PLENUM	150MM GALVANIZED STEEL	1
22	VENTILATION TUBE	150MM GALVANIZED STEEL	1
23	STATIC MIXER	50MM	1
24	TRUE UNION BALL VALVE	50MM SCH 80 PVC	3
25	CHEMTECH INJECTION NOZZLE	6MM	1
26	GUAGE-SNUBBER ASSEMBLY	0-120 PSI LF GUAGE/6MM BV/SNUBBER	5
27	UV PURE FLEX TUBE	18MM STAINLESS STEEL	2
28	BALL VALVE 25MM	2-Piece 600 WOG Brass Ball Valve	5
29	RISER CHECK VALVE	25MM BRASS	2
30	UV PURE SOLENOID VALVE		2
31	BALL VALVE 6MM	2-Piece 600 WOG Brass Ball Valve	4
32	TRUE UNION BALL VALVE	37MM SCH 80 PVC	1
33	TANK TEE	30MM X 330 BRASS	1
34	BALL VALVE 30MM BRASS	2-Piece 600 WOG Brass Ball Valve	1
35	HOSE BIB	20MM BRASS	1
36	PRESSURE SWITCH	40-60 PSI	1
37	BALL VALVE 18MM BRASS	2-Piece 600 WOG Brass Ball Valve	3
38	TRUE UNION BALL VALVE	18MM SCH 80 PVC	2
39	SINK FAUCET ASSEMBLY		1
40	NEEDLE VALVE	McMASTER CARR #4995K13	1
41	TRUE UNION BALL VALVE	25MM SCH 80 PVC	1
45	LOUVERS	406MM X 406MM ALUMINUM	1
46	DAMPER ACTUATOR	BELIMO AF120(-S)US	1
47	PRESSURE TRANSDUCER	ENDRESS & HAUSER PMC 71 0-60 PSI PRESSURE TRANSDUCER	1
48	UV PUR UV DISINFECTION UNIT	UV PURE HALLET 30X	2

PRECISION Ph. 604.850.7010 Fx. 604.850.9666
 SERVICE & PUMPS INC.: 1334 Riverside, Abbotsford B.C. V2S 8J2
EST. 1992 www.precision-pumps.com

PROPRIETARY AND CONFIDENTIAL

THE INFORMATION CONTAINED IN THIS DRAWING IS THE SOLE PROPERTY OF PRECISION SERVICE & PUMPS INC.. ANY REPRODUCTION IN PART OR AS A WHOLE WITHOUT THE WRITTEN PERMISSION OF PRECISION SERVICE & PUMPS INC. IS PROHIBITED.	UNLESS OTHERWISE SPECIFIED:				C.S. JACKSON HEAVY EQUIPMENT SERVICES LTD. SUNSHINE COAST REGIONAL DISTRICT
	DIMENSIONS ARE IN MILLIMETERS		DRAWN	DATE	
	TOLERANCES: ANGULAR: MACH ± .5 BEND ± 1.0 ± 1MM ONE PLACE DECIMAL ± 0.1MM THREE PLACE DECIMAL ± 0.05MM		PT	1/19/2012	
MATERIAL			PSP WO #: 8055		TITLE: RIGHT SIDE WALL
					EGMONT COVE WATER TREATMENT PLANT
					SIZE B
					REV
					SHEET 4 OF 5

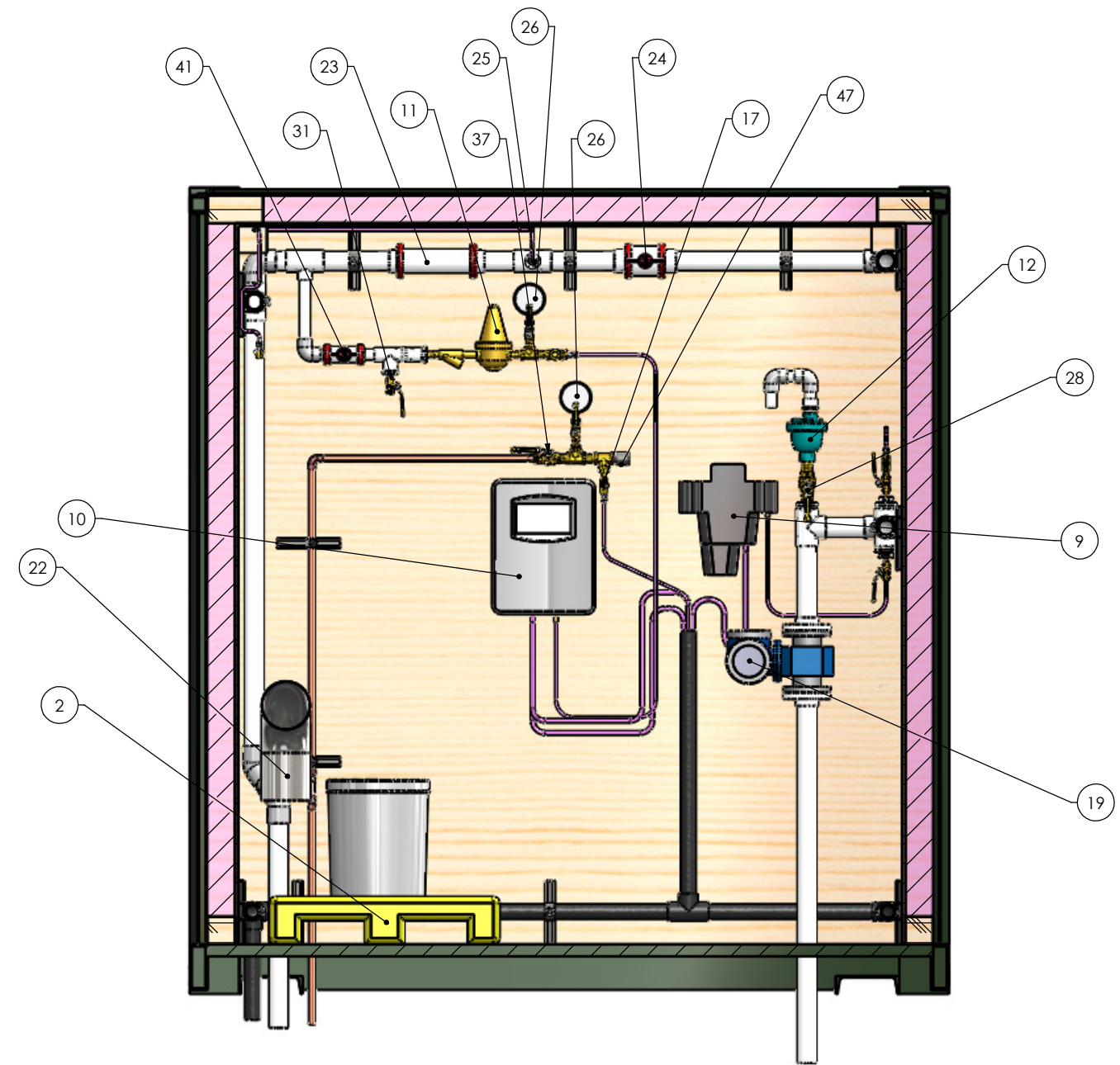
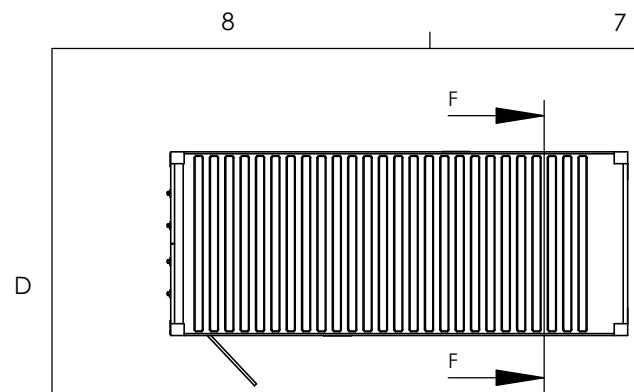

SECTION F-F
SCALE 1 : 20

ITEM NO.	PART NUMBER	DESCRIPTION	QTY.
1	SHIPPING CONTAINER 20FT 8055	C/W INSULATION, PLYWOOD SHEETING & PAINT	1
2	SPILL CONTAINMENT SKID	ENPAC MODEL #5117-YE 83.6 L	1
3	20L PAIL		1
4	HOT WATER TANK	A.O. SMITH DEN-120	1
5	PRESSURE TANK	62 GAL. WELL-X-TROL WX-251	1
6	EMERGENCY EYE WASH & SHOWER	GUARDIAN G1950HFC-FC20	1
7	THERMOSTATIC MIXING VALVE	44 GAL. CAP. GUARDIAN G3800	1
8	LAUNDRY SINK	FL-1 75 LITER	1
9	TURBIDITY ANALYZER	HACH 1720E	1
10	CHLORINE ANALYZER	HACH CL17	1
11	PRESSURE REDUCING VALVE	WATTS 223-S 12MM C/W STRAINER	1
12	AIR RELEASE VALVE	AIR RELEASE VALVE	1
13	IN LINE VENT FAN	FANTECH FR 160 150MM 115V	1
14	FIXED LOUVERS	300MM FLANGED	2
15	CLEARTECH CHLORINATION SYSTEM	DUPLEX GRUNDFOS DDI 209 HYPOCHLORITE METERING SYSTEM	1
16	FLOW METER EH PROMAG 50W	50MM	1
18	TANK PAN	850MM	1
20	PUMP CENTRIFUGAL SELF-PRIMING	GOULDS GT-07	1
21	VENTILATION PLENUM	150MM GALVANIZED STEEL	1
22	VENTILATION TUBE	150MM GALVANIZED STEEL	1
23	STATIC MIXER	50MM	1
24	TRUE UNION BALL VALVE	50MM SCH 80 PVC	3
25	CHEMTECH INJECTION NOZZLE	6MM	1
26	GUAGE-SNUBBER ASSEMBLY	0-120 PSI LF GUAGE/6MM BV/SNUBBER	5
27	UV PURE FLEX TUBE	18MM STAINLESS STEEL	2
28	BALL VALVE 25MM	2-Piece 600 WOG Brass Ball Valve	5
29	RISER CHECK VALVE	25MM BRASS	2
30	UV PURE SOLENOID VALVE		2
31	BALL VALVE 6MM	2-Piece 600 WOG Brass Ball Valve	4
32	TRUE UNION BALL VALVE	37MM SCH 80 PVC	1
33	TANK TEE	30MM X 330 BRASS	1
34	BALL VALVE 30MM BRASS	2-Piece 600 WOG Brass Ball Valve	1
35	HOSE BIB	20MM BRASS	1
36	PRESSURE SWITCH	40-60 PSI	1
37	BALL VALVE 18MM BRASS	2-Piece 600 WOG Brass Ball Valve	3
38	TRUE UNION BALL VALVE	18MM SCH 80 PVC	2
39	SINK FAUCET ASSEMBLY		1
40	NEEDLE VALVE	McMASTER CARR #4995K13	1
41	TRUE UNION BALL VALVE	25MM SCH 80 PVC	1
45	LOUVERS	406MM X 406MM ALUMINUM	1
46	DAMPER ACTUATOR	BELIMO AF120(-S)US	1
47	PRESSURE TRANSDUCER	ENDRESS & HAUSER PMC 71 0-60 PSI PRESSURE TRANSDUCER	1
48	UV PUR UV DISINFECTION UNIT	UV PURE HALLET 30X	2

PRECISION Ph. 604.850.7010 Fx. 604.850.9666
 SERVICE & PUMPS INC.: 1334 Riverside, Abbotsford B.C. V2S 8J2
EST. 1992 www.precision-pumps.com

PROPRIETARY AND CONFIDENTIAL

THE INFORMATION CONTAINED IN THIS DRAWING IS THE SOLE PROPERTY OF PRECISION SERVICE & PUMPS INC.. ANY REPRODUCTION IN PART OR AS A WHOLE WITHOUT THE WRITTEN PERMISSION OF PRECISION SERVICE & PUMPS INC. IS PROHIBITED.

UNLESS OTHERWISE SPECIFIED:
 DIMENSIONS ARE IN MILLIMETERS
 TOLERANCES:
 ANGULAR: MACH ± .5 BEND ± 1.0
 ± 1MM
 ONE PLACE DECIMAL ± 0.1MM
 THREE PLACE DECIMAL ± 0.05MM

	NAME	DATE
DRAWN	PT	1/19/2012
CHECKED		
CHECKED		

C.S. JACKSON HEAVY EQUIPMENT SERVICES LTD.

SUNSHINE COAST REGIONAL DISTRICT

EGMONT COVE WATER TREATMENT PLANT		SIZE B	REV
TITLE: END WALL		SHEET 5 OF 5	

MATERIAL

PSP WO #: 8055